

THIS SHEET INCLUDES FITTING INSTRUCTIONS FOR THE FOLLOWING PARTS:

- Secondary Alternator Cover Part No. EC-SD-1-GBR / Secondary Clutch Cover Part No. EC-SD-2-GBR
Upper Frame Slider Set - Part No. CP-SD-1-SET-GBR / Lower Frame Slider Set - Part No. CP-SD-2-SET-GBR
Lower Chain Guard Part No. CGA10-GBR / Paddock Stand / Bobbin Set Part No. BA12-10-1-5-GBR-SET



SECONDARY ALTERNATOR COVER PART NO. EC-SD-1-GBR

- 1 Remove 4 off existing Bolts on the stock aluminium Alternator cover, corresponding to the Secondary Engine Alternator Cover, shown as Bolt Positions 1, 2, 3 & 4.
- 2 Place the Secondary Alternator Cover over the stock cover aluminium alternator cover. Loosely screw down Bolt 1 (Note: M6X40A2mm) then the remaining 3 Bolts as supplied (M6X35A2mm).
- 3 Tighten bolts to a Torque of 10Nm as per Manufacturer's recommendations. DO NOT OVERTIGHTEN.

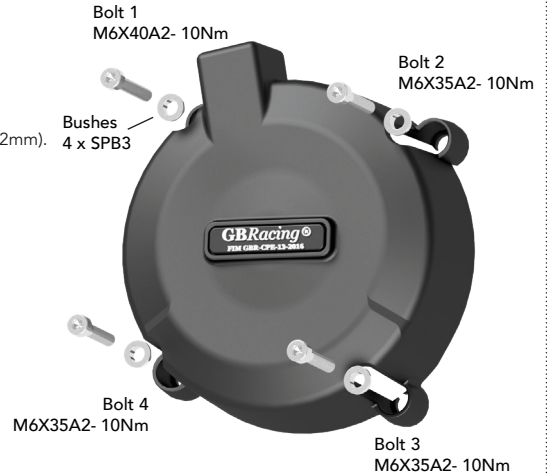
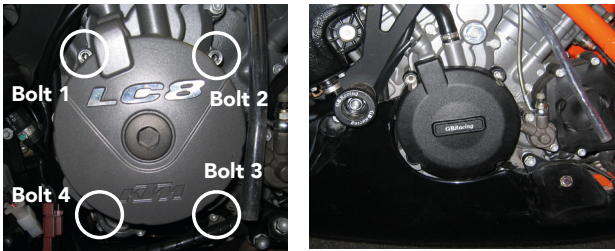

SECONDARY CLUTCH COVER PART NO. EC-SD-2-GBR

- 1 Remove 4 off existing Bolts on the stock aluminium clutch cover, corresponding to the Secondary Engine Clutch Cover, shown as Bolt Positions 1, 2, 3 & 4.
- 2 Place the Secondary Clutch Cover over the stock aluminium cover. Loosely screw down Bolt 1 (Note: M6X90A2mm), then the remaining 3 Bolts as supplied (M6X30A2mm).
- 3 Tighten bolts to a Torque of 10Nm as per Manufacturer's recommendations. DO NOT OVERTIGHTEN.

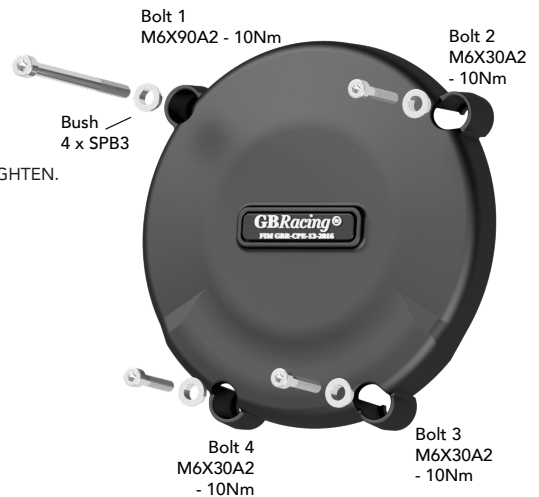
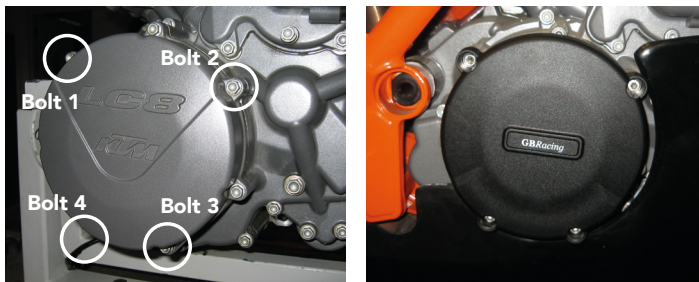

LOWER CHAIN GUARD PART NO. CGA10-GBR

- 1 Assemble 2 bolts and washers through the lower chain guard into the Black Anodised aluminium mounting block CGA10-2.
- 2 Position the assembly underneath the swing arm, closing the gap to the rear sprocket. Note : There should be a 5mm minimum gap from the bike chain to the lower chain guard.
- 3 Mark off the chosen hole positions.
- 4 Drill & Tap the marked holes , M6 - (Drill 5mm Dia. for tapping)
- 5 Disassemble the Black Anodised block from the assembly, and mount the block to the underside of the swing arm using the remaining 2 bolts and washers.
- 6 Re-assemble the lower chain guard to the fixed bracket.



PADDOCK STAND / BOBBIN SET PART NO. BA12-10-1-5-GBR-SET

- 1 Assemble the M10 Stainless Steel bolt through the moulded bobbin and the Black Anodised Bush.
- 2 Tighten bolts to the swing arm boss, 8 N/m. DO NOT OVERTIGHTEN.

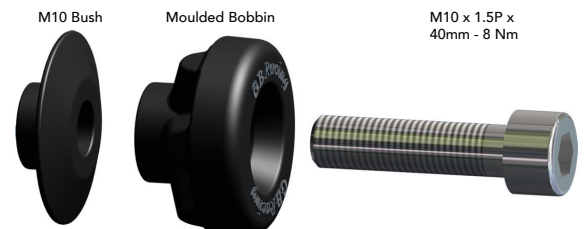
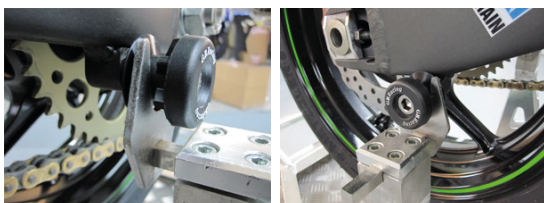

UPPER FRAME SLIDER SET - FITS LC8 ENGINE PART NO. CP-SD-1-SET-GBR

- 1 Remove 2 Stock Bolts from the Upper mounting arm. Shown as Bolt positions 1&2.
- 2 Place the aluminium bracket CP-SD-B1, over the corresponding mounting points.
- 3 Assemble the M10 washers over the M10x40mm bolts, through the bracket and screw into place. Tighten to 40Nm Torque.
- 4 Assemble Crash Mushroom CPF1-GBR to the aluminium bracket CP-SD-B1, using the supplied M10x65mm bolt & M10 washer. Torque to 25Nm. DO NOT OVERTIGHTEN.

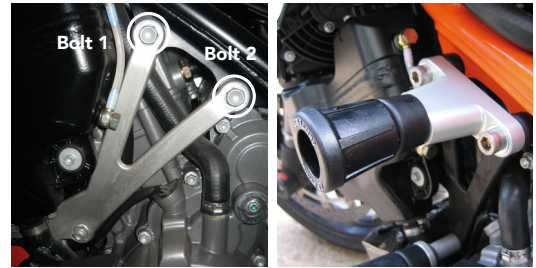

LOWER FRAME SLIDER SET PART NO. CP-SD-2-SET-GBR



LEFT HAND FITTING:

- 1 Unscrew the Lower Engine lock nut, shown as Nut 1, on the lower front engine bolt. You will need to hold the bar, hexagon head, on the opposite end of the bar.
- 2 Use the supplied replacement lower engine bar to knock out the stock lower engine bar. Continue passing the replacement bar through, so that equal amounts of the bar protrude from both sides. *Note: Must use a soft hammer to knock out the stock bar, otherwise damage may be caused to the replacement bar thread end.*
- 3 Assemble the supplied longer aluminium bush over the left hand side replacement bar protrusion, ensuring that the larger bush diameter is away from the bike.
- 4 Slide over 1 of the 2 Crash Mushrooms marked up CPF1-2-GBR.
- 5 Assemble the M10 Washer & lock nut over the protruding thread. Hand tighten the lock.

RIGHT HAND FITTING:

- 1 Assemble the supplied shorter aluminium bush over the right hand side replacement bar protrusion, ensuring that the larger bush diameter is away from the bike.
- 2 Slide over the remaining Crash Mushroom marked up CPF1-2-GBR.
- 3 Assemble the M10 Washer & Lock Nut over the protruding thread. Hand tighten the lock nut.
- 4 To tighten up the lock nuts on both sides you will need to hold replacement bar still, by the slotted screwdriver slot located at each end. Keep tightening up alternate lock nuts until an equal thread protrusion of approximately 5mm is seen from both ends.
- 5 Holding both lock nuts with socket sets, tighten up to 40Nm Torque. DO NOT OVERTIGHTEN

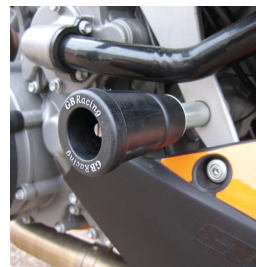
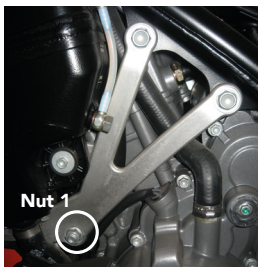

Protection Bundle: CP-SD-CS-GBR

EC-SD-1-GBR, EC-SD-2-GBR, CGA10-GBR, BA12-10-1-5-GBR-SET, CP-SD-1-SET-GBR, CP-SD-2-SET-GBR

Engine Cover Set: EC-SD-SET-GBR

EC-SD-1-GBR, EC-SD-2-GBR