

# MOZ5010

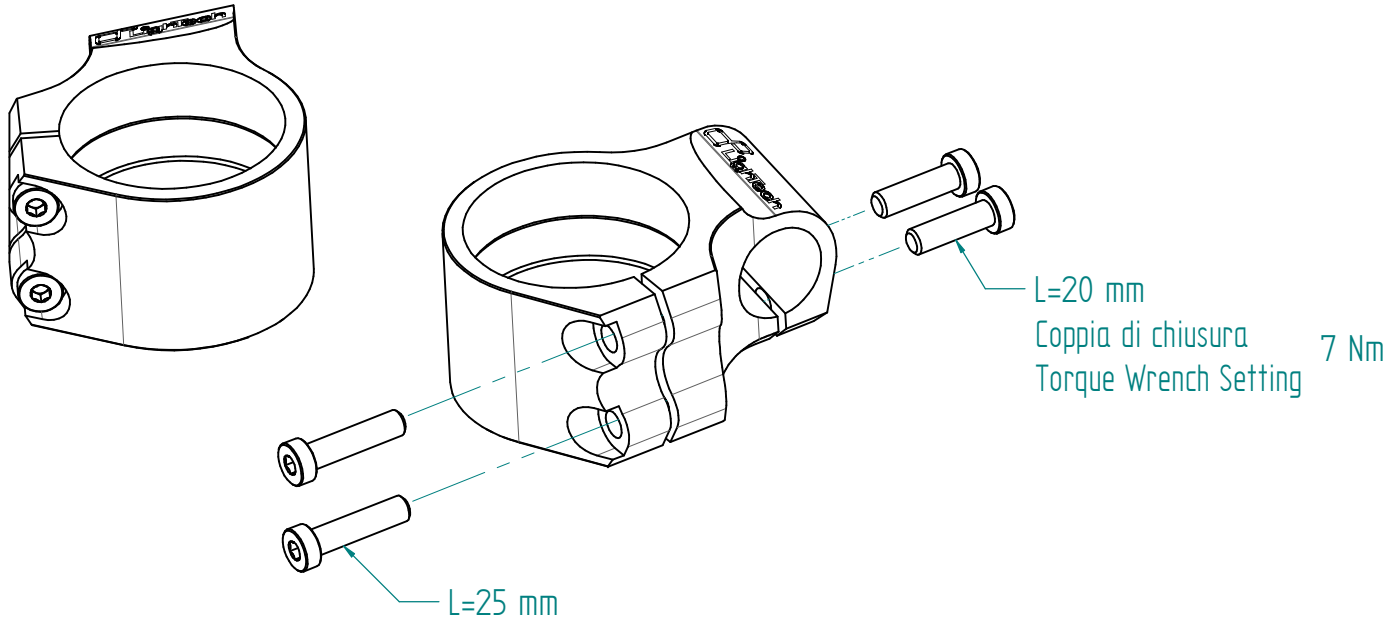

Usare la Coppia di Chiusura consigliata dal costruttore forcella  
Use the Torque Wrench Setting recommended by the fork builder



IT) E' necessario l'intervento di personale professionale per tutti i prodotti che necessitano di installazione.  
EN) The assistance of professional staff is necessary for all parts which require installation.  
ES) Se necesita que sea montado por profesionales para todos los productos que necesitan instalación.  
FR) L'assistance d'un professionnel est nécessaire pour toutes les pièces qui nécessitent une installation.  
DEU) Der Eingriff von Fachpersonal ist notwendig für alle Artikel die installiert/montiert werden müssen.

- VERIFICARE SERRAGGIO VITI PRIMA DELL'UTILIZZO / CONTROL THE THIGHTTENING'S SCREW BEFORE USING