

## Kit Contents

Description	Part No	Pcs
Screw M8x25	15209-01	2
Washer 8/13/1 copper	60048-01	2
Top cap	60005-25	2
O-ring 25.8x3.53	00438-29	2
Comp. damping rod	FDK 106-C	1
Reb. damping rod	FDK 106-R	1
Spring, Fr.fork 5.5 N/mm	68000-04	2
Spring, Fr.fork 6.0 N/mm	68000-05	2
Sleeve 18/25-17.5	61123-08	2
Sticker "ÖHLINS"	00192-01	2
Sticker "ÖHLINS"	01185-01	2
Sticker "ÖHLINS"	01185-04	2

### **Note!**

*Before installing this product, check the contents of the kit. If anything is missing, please contact an Öhlins dealer.*

### **Warning!**

*This kit should only be installed by an authorized Öhlins dealer. The installation procedure requires certain tools.*

### **Warning!**

*Before installing this product, read the Öhlins Owner's Manual. The shock absorber/front fork/steering damper*

### **Note!**

*Please note that this image is a general representation of the product and may differ slightly from your product.*

### **Note!**

*Please note that during storage and transportation, especially at high ambient temperature, some of the oil and grease used for assembling may leak and stain the packaging. This is in no way detrimental to the product, wipe off the excessive oil/grease with a cloth.*

## Fork Damping Kit for Kawasaki Z125 Fork Damping Kit

# **FDK 106**

## Mounting Instructions

# MOUNTING INSTRUCTIONS

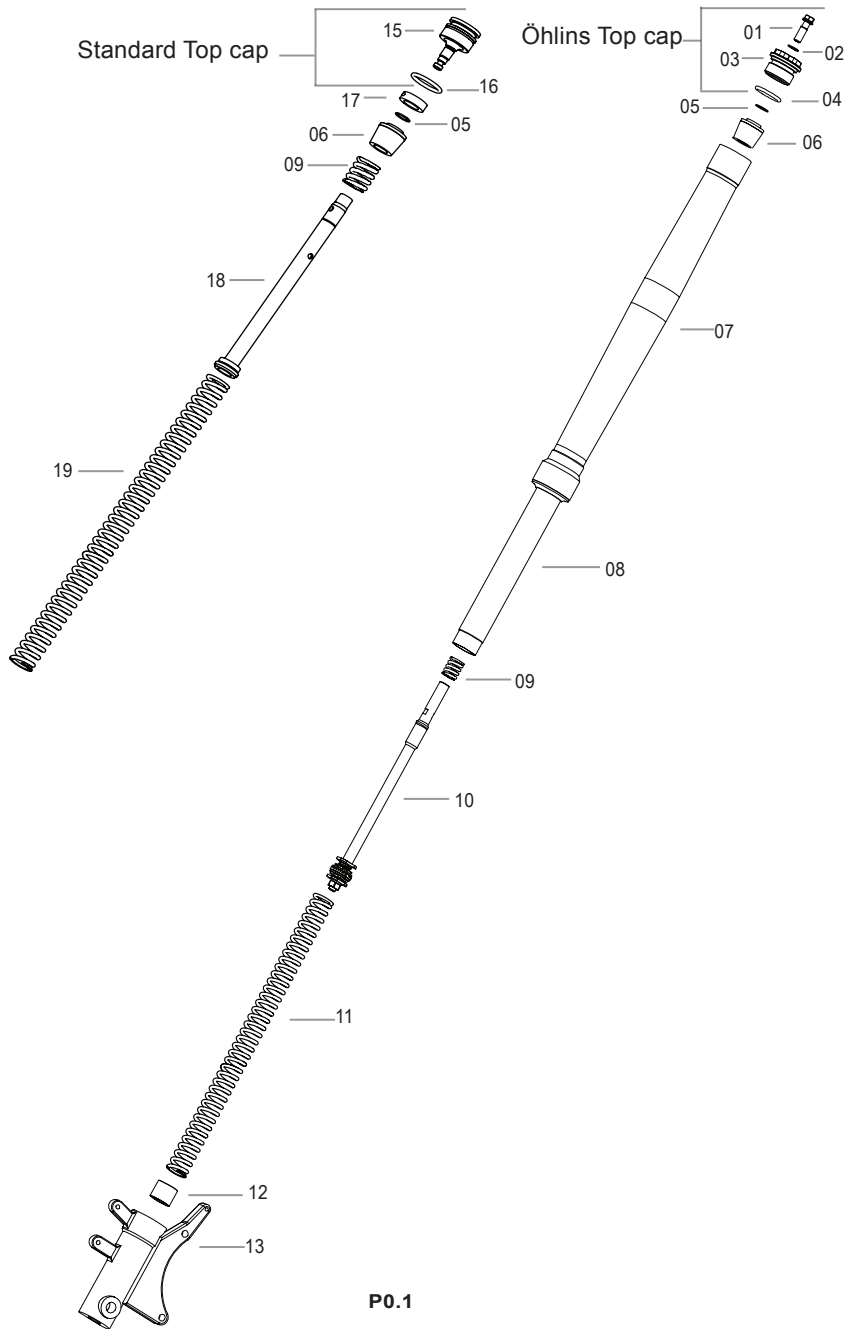

P0.1

# MOUNTING INSTRUCTIONS

## **Note!**

*The front fork is a very important part of the vehicle and will therefore affect the stability.*

## **Note!**

*Read and make sure that you understand the information in this manual before you use this product.*

*If you have any questions regarding installation or maintenance please contact your nearest Öhlins dealer*

## **Note!**

*Öhlins can not be held responsible for any damage to the front fork, vehicle, other property or injury to persons, if the instructions for installing and maintenance are not followed exactly.*

## **Warning!**

*This product was developed and designed exclusively for a specific vehicle model and should only be installed on the intended vehicle model in its original condition as delivered from the vehicle manufacturer.*

*After installing this product, take a test ride at low speed to make sure that your vehicle has maintained its stability.*

## **Note!**

*When working on this product, always consult your Vehicle Service Manual.*

## **Note!**

*This Manual should be considered as a part of the product and should therefore accompany the product throughout its life cycle.*

## Safety Symbols

In this manual, mounting instructions and other technical documents, important information concerning safety is distinguished by the following symbols:

**Warning!** The Safety Alert Symbol means: Warning! Your safety is involved.

### **Warning!**

The Warning Symbol means: Failure to follow warning instructions can result in severe or fatal injury to anyone working with, inspecting or using the front fork, or to bystanders.

### **Caution!**

The Caution Symbol means: Special precautions must be taken to avoid damage to the front fork.

### **Note!**

The Note Symbol indicates information that is important regarding procedures.

## SPECIAL TOOL NEEDED

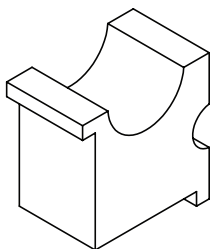

**ÖHLINS SOFT JAWS KIT : 60000-06**

# 1-REMOVE ORIGINAL FRONT FORK

## **Warning!**

*It is advisable to have an Öhlins dealer install the shock absorber/front fork/steering damper.*

## **Warning!**

*If working on a raised vehicle, ensure it is securely supported so that it will not tip.*

## **Warning!**

*Do not scratch ÖHLINS top caps use marking tape*

## **Note!**

*Before mounting this product clean the vehicle thoroughly.*

## **Note!**

*When working on this product, always see the Vehicle Service Manual for vehicle specific procedures and important data.*

### 1.1

Loosen the top triple clamp screws.

### 1.2

Loosen (do not remove) both fork top caps ½ turn.

### 1.3

Remove both the fork legs as per Vehicle Service Manual instructions.

# 2-DISASSEMBLE ORIGINAL FRONT FORK

## 👁 **Note!**

Refer to picture P0.1 for components location.

### 2.1

Remove the lock screws from the fork bottom(13)

## ⚠ **Warning!**

1.It's advisable to have an Öhlins dealer performing this operation.

2.Use a flat end mill  $\varnothing 5$

3.Be carefull of not drilling thru the inner tube (08)

4.Make sure that the inner tube (08) threads have no burrs otherwise it may result in damaging the fork bottom (13) when removing it.

5.See sketch below.

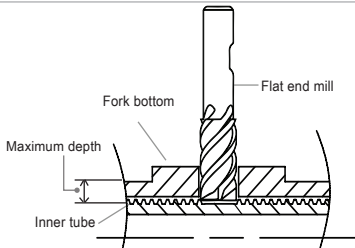

### 2.2

Unscrew the top cap (15) from the outer tube (07) .

### 2.3

Remove the cap safety ring (17) by loosening the set screw .

### 2.4

Drain the fork leg of oil.

### 2.5

Compress the fork rod and clamp the damping rod (18) by using the tool 60000-06.

### 2.6

Remove the top cap (15)

### 2.7

Remove the bump rubber (06) according to the following procedure :

## 👁 **Note!**

Don't damage the bump rubber (06) because it will be used again in the next operations

2.7.1 Open the lips by forcing it with a screw driver

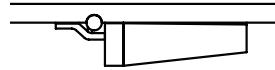
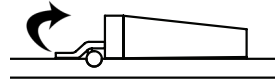

2.7.2 Push the bump rubber (06) toward the outer tube (07)

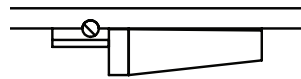
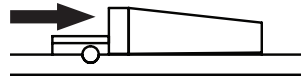

2.7.3 Remove the circlip (05) and remove the bump rubber from the damping rod.

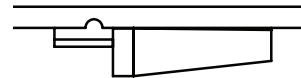

### 2.8

Extend the fork leg until fully stroke and clamp the inner tube (08) by using the tool 60000-06

### 2.9

Use a heat gun to soften the thread-locking adhesive between the inner tube (08) and the fork bottom (13).

### 2.10

Use the motorcycle wheel axle as a lever to loosen the fork bottom (13) from the steel tube (08)

## 👁 **Note!**

Don't remove the shim and o-ring from the fork bottom

## 2-DISASSEMBLE ORIGINAL FRONT FORK

2.11

Remove standard spring (19),the damping rod (18) and the top-out spring (09)

## 3 - INSTALL ÖHLINS FORK DAMPING KIT

### **Caution!**

*The fork damping kit is divided into one compression rod and one rebound rod.*

3.1

Insert the top-out spring (09) and the Öhlins damping rod (10) into the inner tube (08) as per P 3.1

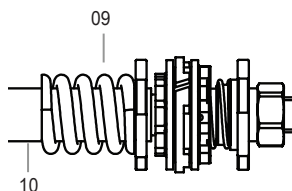

Compression rod - LH Fork Leg

3.2

Extend the fork leg until fully stroke and clamp the inner tube (08) by using the tool 60006-06

3.4

Insert the Öhlins spring (11), the spacer (12) into the inner tube (08).

3.5

Apply Loctite 270 on the inner tube (08) and re-tighten the fork bottom (13) according to the vehicle service manual.



Rebound rod -RH Fork Leg

3.6

Compress the fork and re-install the bump rubber by reversing the procedures 2.7

**P3.1**

3.7

Install the Öhlins top caps (03) to the damping rod (10) by using the screw (01) and the copper washer (02)

Tighten with a torque value of 15 Nm and use Loctite 243.

# 3-INSTALL ÖHLINS FORK DAMPING KIT

## 👁️ **Note!**

*Compress and extend repetitively the fork leg while filling the oil in order to remove the air from it.*

3.8

Fill the fork leg with 200 ml of Öhlins oil 01309-01.

3.9

Extend the fork leg and tighten the Öhlins top cap (03) to the outer tube (07) at a torque value 10 Nm.

3.10

Re-install the fork legs as per Vehicle Service Manual instructions.

## Recommended spring

Spring part No.	Spring rate	For rider weight
68000-04	5.5 N/mm	Below 80 kg
68000-05	6.0 N/mm	Above 80 kg

## DIAGRAM-OIL LEVEL/SPRING FORCE

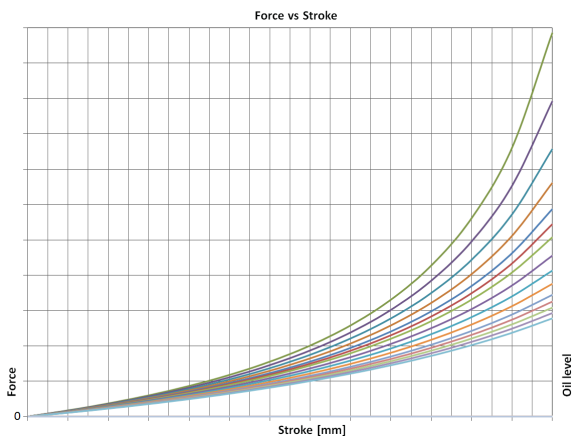

---

👁️ Öhlins products are subject to continuous improvement and development, therefore, although these instructions include the most up-to-date information available at the time of printing, minor updates may occur.

To find the latest information contact an Öhlins distributor. Please contact Öhlins if you have any questions regarding the contents in this document.

Part no. MI\_FDK106\_EN\_0  
Issued 2017-02-27

© Öhlins Asia Co. Ltd. All rights reserved. Any reprinting or unauthorized use without the written permission of Öhlins Racing AB is prohibited.

Öhlins Asia Co. Ltd  
700/937 Moo5, Tambol Nongkhaga,  
Amphur Phantong, Chonburi Province  
20160 Thailand



[www.ohlins.com](http://www.ohlins.com)